

Article number: 3901210015300

Description: Worm gear with solid input shaft
VF 210V-15-HS

Measures

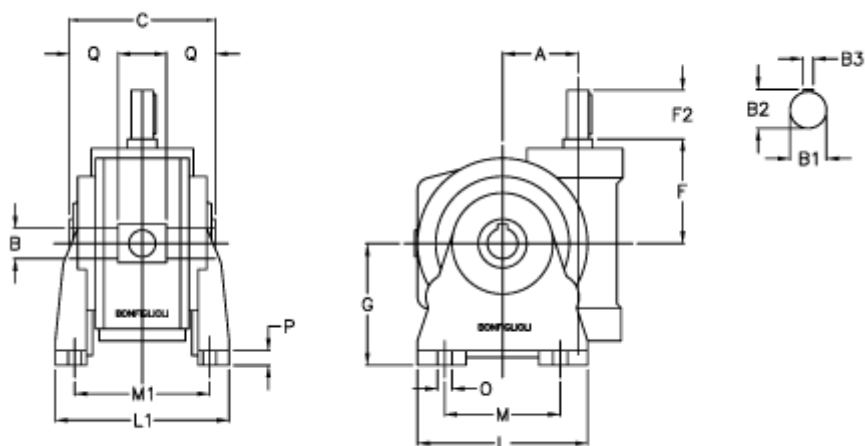

a	= 210.0	F2 = 110	Q = 85.0
B	= 90	g = 335	
B1	= 48	L = 440	
B2	= 51.5	L1 = 320	
B3	= 14	m = 340	
C	= 260	M1 = 265.0	
Description	= VF 210V-xx-HS	O = 26.0	
F	= 230.0	P = 25	